

SECTION 1 (Maximum Marks: 12)

- This section contains **FOUR (04)** questions.
- Each question has **FOUR** options (A), (B), (C) and (D). **ONLY ONE** of these four options is the correct answer.
- For each question, choose the option corresponding to the correct answer.
- Answer to each question will be evaluated according to the following marking scheme:
Full Marks : +3 If **ONLY** the correct option is chosen;
Zero Marks : 0 If none of the options is chosen (i.e. the question is unanswered);
Negative Marks : -1 In all other cases.

Q.1 Considering only the principal values of the inverse trigonometric functions, the value of

$$\tan\left(\sin^{-1}\left(\frac{3}{5}\right) - 2\cos^{-1}\left(\frac{2}{\sqrt{5}}\right)\right)$$

is

- | | |
|---------------------|---------------------|
| (A) $\frac{7}{24}$ | (B) $\frac{-7}{24}$ |
| (C) $\frac{-5}{24}$ | (D) $\frac{5}{24}$ |

Q.2 Let $S = \{(x, y) \in \mathbb{R} \times \mathbb{R} : x \geq 0, y \geq 0, y^2 \leq 4x, y^2 \leq 12 - 2x \text{ and } 3y + \sqrt{8}x \leq 5\sqrt{8}\}$. If the area of the region S is $\alpha\sqrt{2}$, then α is equal to

- | | | | |
|--------------------|--------------------|--------------------|--------------------|
| (A) $\frac{17}{2}$ | (B) $\frac{17}{3}$ | (C) $\frac{17}{4}$ | (D) $\frac{17}{5}$ |
|--------------------|--------------------|--------------------|--------------------|

Q.3 Let $k \in \mathbb{R}$. If $\lim_{x \rightarrow 0^+} (\sin(\sin kx) + \cos x + x)^{\frac{2}{x}} = e^6$, then the value of k is

- | | | | |
|-------|-------|-------|-------|
| (A) 1 | (B) 2 | (C) 3 | (D) 4 |
|-------|-------|-------|-------|

Q.4 Let $f : \mathbb{R} \rightarrow \mathbb{R}$ be a function defined by

$$f(x) = \begin{cases} x^2 \sin\left(\frac{\pi}{x^2}\right), & \text{if } x \neq 0, \\ 0, & \text{if } x = 0. \end{cases}$$

Then which of the following statements is TRUE?

- (A) $f(x) = 0$ has infinitely many solutions in the interval $\left[\frac{1}{10^{10}}, \infty\right)$.
- (B) $f(x) = 0$ has no solutions in the interval $\left[\frac{1}{\pi}, \infty\right)$.
- (C) The set of solutions of $f(x) = 0$ in the interval $\left(0, \frac{1}{10^{10}}\right)$ is finite.
- (D) $f(x) = 0$ has more than 25 solutions in the interval $\left(\frac{1}{\pi^2}, \frac{1}{\pi}\right)$.

SECTION 2 (Maximum Marks: 12)

- This section contains **THREE (03)** questions.
- Each question has **FOUR** options (A), (B), (C) and (D). **ONE OR MORE THAN ONE** of these four option(s) is (are) correct answer(s).
- For each question, choose the option(s) corresponding to (all) the correct answer(s).
- Answer to each question will be evaluated according to the following marking scheme:
 - Full Marks* : +4 **ONLY** if (all) the correct option(s) is(are) chosen;
 - Partial Marks* : +3 If all the four options are correct but **ONLY** three options are chosen;
 - Partial Marks* : +2 If three or more options are correct but **ONLY** two options are chosen, both of which are correct;
 - Partial Marks* : +1 If two or more options are correct but **ONLY** one option is chosen and it is a correct option;
 - Zero Marks* : 0 If unanswered;
 - Negative Marks* : -2 In all other cases.
- For example, in a question, if (A), (B) and (D) are the **ONLY** three options corresponding to correct answers, then
 - choosing **ONLY** (A), (B) and (D) will get +4 marks;
 - choosing **ONLY** (A) and (B) will get +2 marks;
 - choosing **ONLY** (A) and (D) will get +2 marks;
 - choosing **ONLY** (B) and (D) will get +2 marks;
 - choosing **ONLY** (A) will get +1 mark;
 - choosing **ONLY** (B) will get +1 mark;
 - choosing **ONLY** (D) will get +1 mark;
 - choosing no option(s) (i.e. the question is unanswered) will get 0 marks and
 - choosing any other option(s) will get -2 marks.

Q.5 Let S be the set of all $(\alpha, \beta) \in \mathbb{R} \times \mathbb{R}$ such that

$$\lim_{x \rightarrow \infty} \frac{\sin(x^2)(\log_e x)^\alpha \sin\left(\frac{1}{x^2}\right)}{x^{\alpha\beta} (\log_e(1+x))^\beta} = 0.$$

Then which of the following is (are) correct?

- (A) $(-1, 3) \in S$
- (B) $(-1, 1) \in S$
- (C) $(1, -1) \in S$
- (D) $(1, -2) \in S$

Q.6 A straight line drawn from the point $P(1, 3, 2)$, parallel to the line $\frac{x-2}{1} = \frac{y-4}{2} = \frac{z-6}{1}$, intersects the plane $L_1 : x - y + 3z = 6$ at the point Q . Another straight line which passes through Q and is perpendicular to the plane L_1 intersects the plane $L_2 : 2x - y + z = -4$ at the point R . Then which of the following statements is (are) TRUE?

- (A) The length of the line segment PQ is $\sqrt{6}$
- (B) The coordinates of R are $(1, 6, 3)$
- (C) The centroid of the triangle PQR is $\left(\frac{4}{3}, \frac{14}{3}, \frac{5}{3}\right)$
- (D) The perimeter of the triangle PQR is $\sqrt{2} + \sqrt{6} + \sqrt{11}$

Q.7 Let A_1, B_1, C_1 be three points in the xy -plane. Suppose that the lines A_1C_1 and B_1C_1 are tangents to the curve $y^2 = 8x$ at A_1 and B_1 , respectively. If $O = (0, 0)$ and $C_1 = (-4, 0)$, then which of the following statements is (are) TRUE?

- (A) The length of the line segment OA_1 is $4\sqrt{3}$
- (B) The length of the line segment A_1B_1 is 16
- (C) The orthocenter of the triangle $A_1B_1C_1$ is $(0, 0)$
- (D) The orthocenter of the triangle $A_1B_1C_1$ is $(1, 0)$

SECTION 3 (Maximum Marks: 24)

- This section contains **SIX (06)** questions.
- The answer to each question is a **NON-NEGATIVE INTEGER**.
- For each question, enter the correct integer corresponding to the answer using the mouse and the on-screen virtual numeric keypad in the place designated to enter the answer.
- Answer to each question will be evaluated according to the following marking scheme:
Full Marks : +4 If **ONLY** the correct integer is entered;
Zero Marks : 0 In all other cases.

Q.8 Let $f : \mathbb{R} \rightarrow \mathbb{R}$ be a function such that $f(x+y) = f(x) + f(y)$ for all $x, y \in \mathbb{R}$, and $g : \mathbb{R} \rightarrow (0, \infty)$ be a function such that $g(x+y) = g(x)g(y)$ for all $x, y \in \mathbb{R}$. If $f\left(\frac{-3}{5}\right) = 12$ and $g\left(\frac{-1}{3}\right) = 2$, then the value of $\left(f\left(\frac{1}{4}\right) + g(-2) - 8\right)g(0)$ is _____.

Q.9 A bag contains N balls out of which 3 balls are white, 6 balls are green, and the remaining balls are blue. Assume that the balls are identical otherwise. Three balls are drawn randomly one after the other without replacement. For $i = 1, 2, 3$, let W_i, G_i , and B_i denote the events that the ball drawn in the i^{th} draw is a white ball, green ball, and blue ball, respectively. If the probability $P(W_1 \cap G_2 \cap B_3) = \frac{2}{5N}$ and the conditional probability $P(B_3 | W_1 \cap G_2) = \frac{2}{9}$, then N equals _____.

Q.10 Let the function $f : \mathbb{R} \rightarrow \mathbb{R}$ be defined by

$$f(x) = \frac{\sin x (x^{2023} + 2024x + 2025)}{e^{\pi x} (x^2 - x + 3)} + \frac{2 (x^{2023} + 2024x + 2025)}{e^{\pi x} (x^2 - x + 3)}.$$

Then the number of solutions of $f(x) = 0$ in \mathbb{R} is _____.

Q.11 Let $\vec{p} = 2\hat{i} + \hat{j} + 3\hat{k}$ and $\vec{q} = \hat{i} - \hat{j} + \hat{k}$. If for some real numbers α, β , and γ , we have $15\hat{i} + 10\hat{j} + 6\hat{k} = \alpha(2\vec{p} + \vec{q}) + \beta(\vec{p} - 2\vec{q}) + \gamma(\vec{p} \times \vec{q})$, then the value of γ is _____.

- Q.12 A normal with slope $\frac{1}{\sqrt{6}}$ is drawn from the point $(0, -\alpha)$ to the parabola $x^2 = -4ay$, where $a > 0$. Let L be the line passing through $(0, -\alpha)$ and parallel to the directrix of the parabola. Suppose that L intersects the parabola at two points A and B . Let r denote the length of the latus rectum and s denote the square of the length of the line segment AB . If $r : s = 1 : 16$, then the value of $24a$ is _____.

- Q.13 Let the function $f : [1, \infty) \rightarrow \mathbb{R}$ be defined by

$$f(t) = \begin{cases} (-1)^{n+1} 2, & \text{if } t = 2n-1, n \in \mathbb{N}, \\ \frac{(2n+1-t)}{2} f(2n-1) + \frac{(t-(2n-1))}{2} f(2n+1), & \text{if } 2n-1 < t < 2n+1, n \in \mathbb{N}. \end{cases}$$

Define $g(x) = \int_1^x f(t) dt$, $x \in (1, \infty)$. Let α denote the number of solutions of the equation

$g(x) = 0$ in the interval $(1, 8]$ and $\beta = \lim_{x \rightarrow 1^+} \frac{g(x)}{x-1}$. Then the value of $\alpha + \beta$ is equal to _____.

SECTION 4 (Maximum Marks: 12)

- This section contains **TWO (02)** paragraphs.
- Based on each paragraph, there are **TWO (02)** questions.
- The answer to each question is a **NUMERICAL VALUE**.
- For each question, enter the correct numerical value of the answer using the mouse and the on-screen virtual numeric keypad in the place designated to enter the answer.
- If the numerical value has more than two decimal places, **truncate/round-off** the value to **TWO** decimal places.
- Answer to each question will be evaluated according to the following marking scheme:
Full Marks : +3 If **ONLY** the correct numerical value is entered in the designated place;
Zero Marks : 0 In all other cases.

PARAGRAPH “I”

Let $S = \{1, 2, 3, 4, 5, 6\}$ and X be the set of all relations R from S to S that satisfy both the following properties:

- R has exactly 6 elements.
- For each $(a, b) \in R$, we have $|a - b| \geq 2$.

Let $Y = \{R \in X : \text{The range of } R \text{ has exactly one element}\}$ and

$Z = \{R \in X : R \text{ is a function from } S \text{ to } S\}$.

Let $n(A)$ denote the number of elements in a set A .

(There are two questions based on PARAGRAPH “I”, the question given below is one of them)

Q.14 If $n(X) = {}^m C_6$, then the value of m is _____.

PARAGRAPH “I”

Let $S = \{1, 2, 3, 4, 5, 6\}$ and X be the set of all relations R from S to S that satisfy both the following properties:

- R has exactly 6 elements.
- For each $(a, b) \in R$, we have $|a - b| \geq 2$.

Let $Y = \{R \in X : \text{The range of } R \text{ has exactly one element}\}$ and

$Z = \{R \in X : R \text{ is a function from } S \text{ to } S\}$.

Let $n(A)$ denote the number of elements in a set A .

(There are two questions based on PARAGRAPH “I”, the question given below is one of them)

Q.15 If the value of $n(Y) + n(Z)$ is k^2 , then $|k|$ is _____.

PARAGRAPH “II”

Let $f : \left[0, \frac{\pi}{2}\right] \rightarrow [0, 1]$ be the function defined by $f(x) = \sin^2 x$ and let $g : \left[0, \frac{\pi}{2}\right] \rightarrow [0, \infty)$ be the function defined by $g(x) = \sqrt{\frac{\pi x}{2} - x^2}$.

(There are two questions based on PARAGRAPH “II”, the question given below is one of them)

Q.16 The value of $2 \int_0^{\frac{\pi}{2}} f(x)g(x)dx - \int_0^{\frac{\pi}{2}} g(x)dx$ is _____.

PARAGRAPH “II”

Let $f : \left[0, \frac{\pi}{2}\right] \rightarrow [0, 1]$ be the function defined by $f(x) = \sin^2 x$ and let $g : \left[0, \frac{\pi}{2}\right] \rightarrow [0, \infty)$ be the function defined by $g(x) = \sqrt{\frac{\pi x}{2} - x^2}$.

(There are two questions based on PARAGRAPH “II”, the question given below is one of them)

Q.17 The value of $\frac{16}{\pi^3} \int_0^{\frac{\pi}{2}} f(x)g(x)dx$ is _____.

END OF THE QUESTION PAPER

SECTION 1 (Maximum Marks: 12)

- This section contains **FOUR (04)** questions.
- Each question has **FOUR** options (A), (B), (C) and (D). **ONLY ONE** of these four options is the correct answer.
- For each question, choose the option corresponding to the correct answer.
- Answer to each question will be evaluated according to the following marking scheme:
Full Marks : +3 If **ONLY** the correct option is chosen;
Zero Marks : 0 If none of the options is chosen (i.e. the question is unanswered);
Negative Marks : -1 In all other cases.

Q.1 A region in the form of an equilateral triangle (in x - y plane) of height L has a uniform magnetic field \vec{B} pointing in the $+z$ -direction. A conducting loop PQR, in the form of an equilateral triangle of the same height L , is placed in the x - y plane with its vertex P at $x = 0$ in the orientation shown in the figure. At $t = 0$, the loop starts entering the region of the magnetic field with a uniform velocity \vec{v} along the $+x$ -direction. The plane of the loop and its orientation remain unchanged throughout its motion.

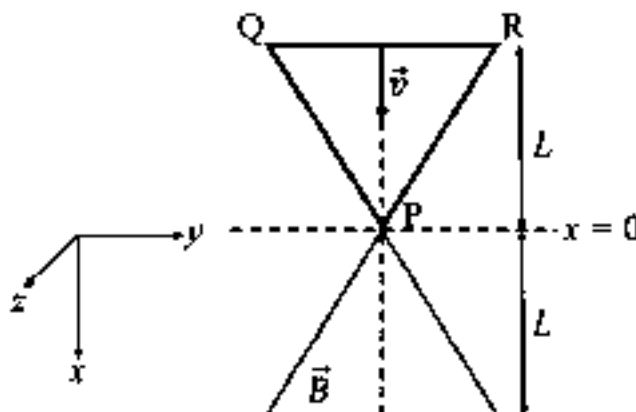

Which of the following graph best depicts the variation of the induced emf (E) in the loop as a function of the distance (x) starting from $x = 0$?

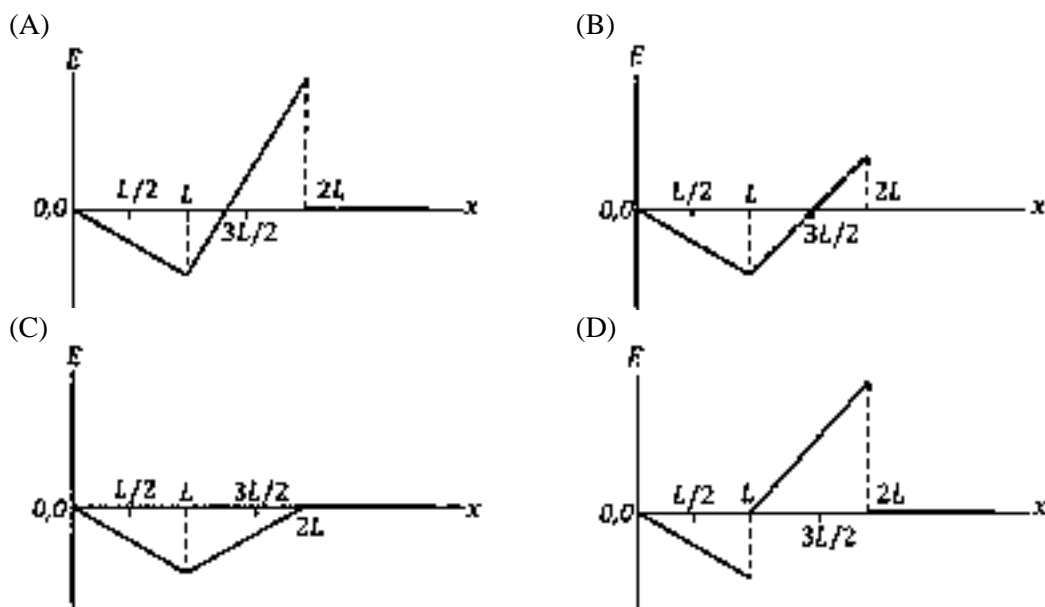

- Q.2 A particle of mass m is under the influence of the gravitational field of a body of mass M ($\gg m$). The particle is moving in a circular orbit of radius r_0 with time period T_0 around the mass M . Then, the particle is subjected to an additional central force, corresponding to the potential energy $V_c(r) = m\alpha/r^3$, where α is a positive constant of suitable dimensions and r is the distance from the center of the orbit. If the particle moves in the same circular orbit of radius r_0 in the combined gravitational potential due to M and $V_c(r)$, but with a new time period T_1 , then $(T_1^2 - T_0^2)/T_1^2$ is given by

[G is the gravitational constant.]

- (A) $\frac{3\alpha}{GMr_0^2}$ (B) $\frac{\alpha}{2GMr_0^2}$ (C) $\frac{\alpha}{GMr_0^2}$ (D) $\frac{2\alpha}{GMr_0^2}$

- Q.3 A metal target with atomic number $Z = 46$ is bombarded with a high energy electron beam. The emission of X-rays from the target is analyzed. The ratio r of the wavelengths of the K_α -line and the cut-off is found to be $r = 2$. If the same electron beam bombards another metal target with $Z = 41$, the value of r will be

- (A) 2.53 (B) 1.27 (C) 2.24 (D) 1.58

- Q.4 A thin stiff insulated metal wire is bent into a circular loop with its two ends extending tangentially from the same point of the loop. The wire loop has mass m and radius r and it is in a uniform vertical magnetic field B_0 , as shown in the figure. Initially, it hangs vertically downwards, because of acceleration due to gravity g , on two conducting supports at P and Q. When a current I is passed through the loop, the loop turns about the line PQ by an angle θ given by

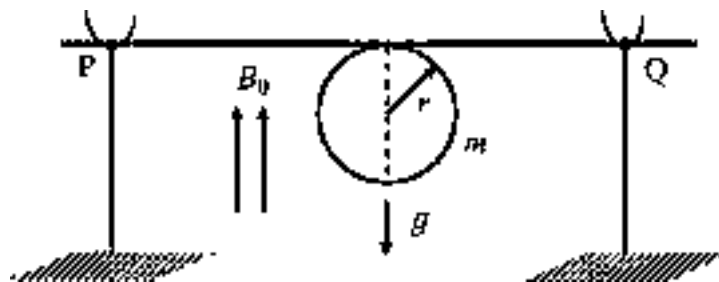

- (A) $\tan \theta = \pi r I B_0 / (mg)$ (B) $\tan \theta = 2\pi r I B_0 / (mg)$
 (C) $\tan \theta = \pi r I B_0 / (2mg)$ (D) $\tan \theta = mg / (\pi r I B_0)$

SECTION 2 (Maximum Marks: 12)

- This section contains **THREE (03)** questions.
- Each question has **FOUR** options (A), (B), (C) and (D). **ONE OR MORE THAN ONE** of these four option(s) is (are) correct answer(s).
- For each question, choose the option(s) corresponding to (all) the correct answer(s).
- Answer to each question will be evaluated according to the following marking scheme:
 - Full Marks* : +4 **ONLY** if (all) the correct option(s) is(are) chosen;
 - Partial Marks* : +3 If all the four options are correct but **ONLY** three options are chosen;
 - Partial Marks* : +2 If three or more options are correct but **ONLY** two options are chosen, both of which are correct;
 - Partial Marks* : +1 If two or more options are correct but **ONLY** one option is chosen and it is a correct option;
 - Zero Marks* : 0 If unanswered;
 - Negative Marks* : -2 In all other cases.
- For example, in a question, if (A), (B) and (D) are the **ONLY** three options corresponding to correct answers, then
 - choosing **ONLY** (A), (B) and (D) will get +4 marks;
 - choosing **ONLY** (A) and (B) will get +2 marks;
 - choosing **ONLY** (A) and (D) will get +2marks;
 - choosing **ONLY** (B) and (D) will get +2 marks;
 - choosing **ONLY** (A) will get +1 mark;
 - choosing **ONLY** (B) will get +1 mark;
 - choosing **ONLY** (D) will get +1 mark;
 - choosing no option(s) (i.e. the question is unanswered) will get 0 marks and
 - choosing any other option(s) will get -2 marks.

- Q.5 A small electric dipole \vec{p}_0 , having a moment of inertia I about its center, is kept at a distance r from the center of a spherical shell of radius R . The surface charge density σ is uniformly distributed on the spherical shell. The dipole is initially oriented at a small angle θ as shown in the figure. While staying at a distance r , the dipole is free to rotate about its center.

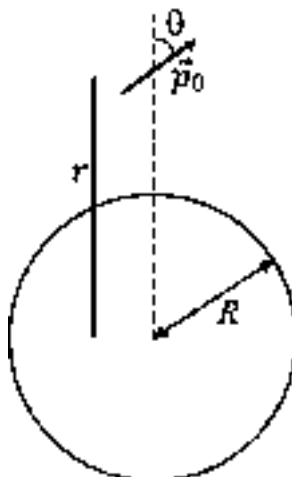

If released from rest, then which of the following statement(s) is(are) correct?

[ϵ_0 is the permittivity of free space.]

- (A) The dipole will undergo small oscillations at any finite value of r .
 (B) The dipole will undergo small oscillations at any finite value of $r > R$.
 (C) The dipole will undergo small oscillations with an angular frequency of $\sqrt{\frac{2\sigma p_0}{\epsilon_0 I}}$ at $r = 2R$.
 (D) The dipole will undergo small oscillations with an angular frequency of $\sqrt{\frac{\sigma p_0}{100\epsilon_0 I}}$ at $r = 10R$.

- Q.6 A table tennis ball has radius $(3/2) \times 10^{-2}$ m and mass $(22/7) \times 10^{-3}$ kg. It is slowly pushed down into a swimming pool to a depth of $d = 0.7$ m below the water surface and then released from rest. It emerges from the water surface at speed v , without getting wet, and rises up to a height H . Which of the following option(s) is(are) correct?

[Given: $\pi = 22/7$, $g = 10 \text{ m s}^{-2}$, density of water = $1 \times 10^3 \text{ kg m}^{-3}$, viscosity of water = $1 \times 10^{-3} \text{ Pa-s}$.]

- (A) The work done in pushing the ball to the depth d is 0.077 J.
 (B) If we neglect the viscous force in water, then the speed $v = 7 \text{ m/s}$.
 (C) If we neglect the viscous force in water, then the height $H = 1.4 \text{ m}$.
 (D) The ratio of the magnitudes of the net force excluding the viscous force to the maximum viscous force in water is 500/9.

- Q.7 A positive, singly ionized atom of mass number A_M is accelerated from rest by the voltage 192 V. Thereafter, it enters a rectangular region of width w with magnetic field $\vec{B}_0 = 0.1\hat{k}$ Tesla, as shown in the figure. The ion finally hits a detector at the distance x below its starting trajectory.

[Given: Mass of neutron/proton = $(5/3) \times 10^{-27}$ kg, charge of the electron = 1.6×10^{-19} C.]

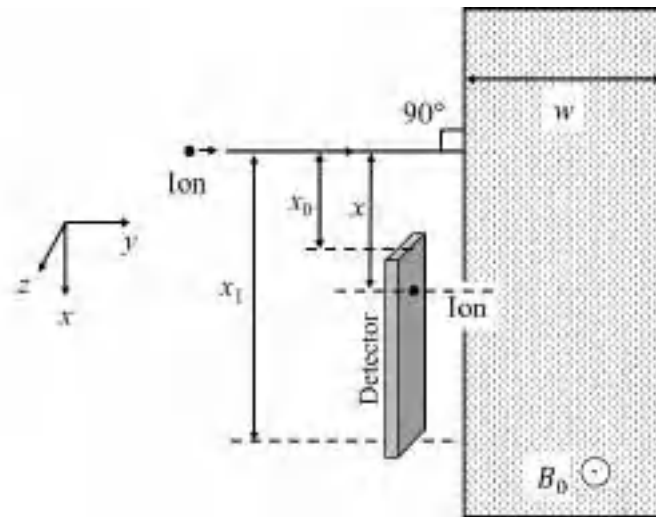

Which of the following option(s) is(are) correct?

- (A) The value of x for H^+ ion is 4 cm.
 (B) The value of x for an ion with $A_M = 144$ is 48 cm.
 (C) For detecting ions with $1 \leq A_M \leq 196$, the minimum height ($x_1 - x_0$) of the detector is 55 cm.
 (D) The minimum width w of the region of the magnetic field for detecting ions with $A_M = 196$ is 56 cm.

SECTION 3 (Maximum Marks: 24)

- This section contains **SIX (06)** questions.
- The answer to each question is a **NON-NEGATIVE INTEGER**.
- For each question, enter the correct integer corresponding to the answer using the mouse and the on-screen virtual numeric keypad in the place designated to enter the answer.
- Answer to each question will be evaluated according to the following marking scheme:
Full Marks : +4 If **ONLY** the correct integer is entered;
Zero Marks : 0 In all other cases.

- Q.8 The dimensions of a cone are measured using a scale with a least count of 2 mm. The diameter of the base and the height are both measured to be 20.0 cm. The maximum percentage error in the determination of the volume is _____.
- Q.9 A ball is thrown from the location $(x_0, y_0) = (0, 0)$ of a horizontal playground with an initial speed v_0 at an angle θ_0 from the $+x$ -direction. The ball is to be hit by a stone, which is thrown at the same time from the location $(x_1, y_1) = (L, 0)$. The stone is thrown at an angle $(180 - \theta_1)$ from the $+x$ -direction with a suitable initial speed. For a fixed v_0 , when $(\theta_0, \theta_1) = (45^\circ, 45^\circ)$, the stone hits the ball after time T_1 , and when $(\theta_0, \theta_1) = (60^\circ, 30^\circ)$, it hits the ball after time T_2 . In such a case, $(T_1/T_2)^2$ is _____.
- Q.10 A charge is kept at the central point P of a cylindrical region. The two edges subtend a half-angle θ at P, as shown in the figure. When $\theta = 30^\circ$, then the electric flux through the curved surface of the cylinder is Φ . If $\theta = 60^\circ$, then the electric flux through the curved surface becomes Φ/\sqrt{n} , where the value of n is _____.

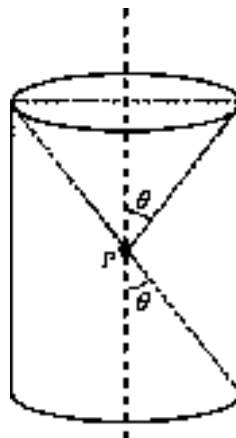

- Q.11 Two equilateral-triangular prisms P_1 and P_2 are kept with their sides parallel to each other, in vacuum, as shown in the figure. A light ray enters prism P_1 at an angle of incidence θ such that the outgoing ray undergoes minimum deviation in prism P_2 . If the respective refractive indices of P_1 and P_2 are $\sqrt{\frac{3}{2}}$ and $\sqrt{3}$, then $\theta = \sin^{-1} \left[\sqrt{\frac{3}{2}} \sin \left(\frac{\pi}{\beta} \right) \right]$, where the value of β is _____.

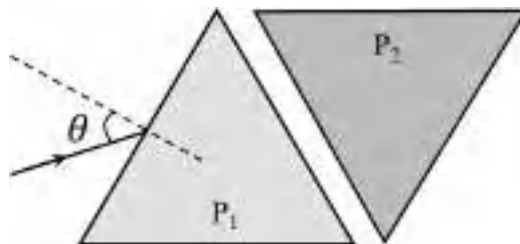

- Q.12 An infinitely long thin wire, having a uniform charge density per unit length of 5 nC/m , is passing through a spherical shell of radius 1 m , as shown in the figure. A 10 nC charge is distributed uniformly over the spherical shell. If the configuration of the charges remains static, the magnitude of the potential difference between points P and R, in Volt, is _____.

[Given: In SI units $\frac{1}{4\pi\epsilon_0} = 9 \times 10^9$, $\ln 2 = 0.7$. Ignore the area pierced by the wire.]

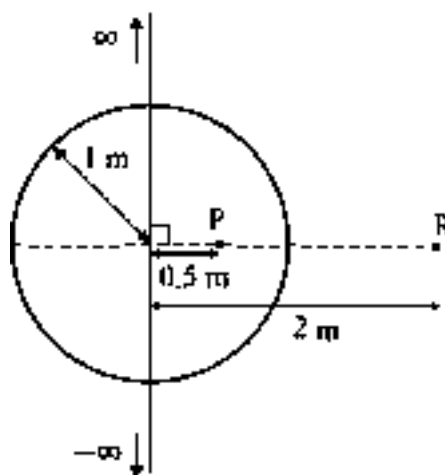

- Q.13 A spherical soap bubble inside an air chamber at pressure $P_0 = 10^5 \text{ Pa}$ has a certain radius so that the excess pressure inside the bubble is $\Delta P = 144 \text{ Pa}$. Now, the chamber pressure is reduced to $8P_0/27$ so that the bubble radius and its excess pressure change. In this process, all the temperatures remain unchanged. Assume air to be an ideal gas and the excess pressure ΔP in both the cases to be much smaller than the chamber pressure. The new excess pressure ΔP in Pa is _____.

SECTION 4 (Maximum Marks: 12)

- This section contains **TWO (02)** paragraphs.
- Based on each paragraph, there are **TWO (02)** questions.
- The answer to each question is a **NUMERICAL VALUE**.
- For each question, enter the correct numerical value of the answer using the mouse and the on-screen virtual numeric keypad in the place designated to enter the answer.
- If the numerical value has more than two decimal places, **truncate/round-off** the value to **TWO** decimal places.
- Answer to each question will be evaluated according to the following marking scheme:
Full Marks : +3 If ONLY the correct numerical value is entered in the designated place;
Zero Marks : 0 In all other cases.

PARAGRAPH I

In a Young's double slit experiment, each of the two slits A and B, as shown in the figure, are oscillating about their fixed center and with a mean separation of 0.8 mm. The distance between the slits at time t is given by $d = (0.8 + 0.04 \sin \omega t)$ mm, where $\omega = 0.08 \text{ rad s}^{-1}$. The distance of the screen from the slits is 1 m and the wavelength of the light used to illuminate the slits is 6000 \AA . The interference pattern on the screen changes with time, while the central bright fringe (zeroth fringe) remains fixed at point O.

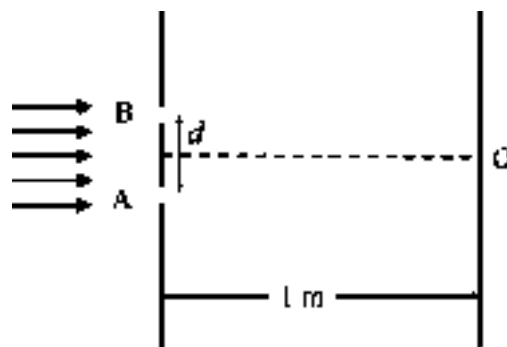

- Q.14 The 8th bright fringe above the point O oscillates with time between two extreme positions. The separation between these two extreme positions, in micrometer (μm), is _____.

PARAGRAPH I

In a Young's double slit experiment, each of the two slits A and B, as shown in the figure, are oscillating about their fixed center and with a mean separation of 0.8 mm. The distance between the slits at time t is given by $d = (0.8 + 0.04 \sin \omega t)$ mm, where $\omega = 0.08 \text{ rad s}^{-1}$. The distance of the screen from the slits is 1 m and the wavelength of the light used to illuminate the slits is 6000 \AA . The interference pattern on the screen changes with time, while the central bright fringe (zeroth fringe) remains fixed at point O.

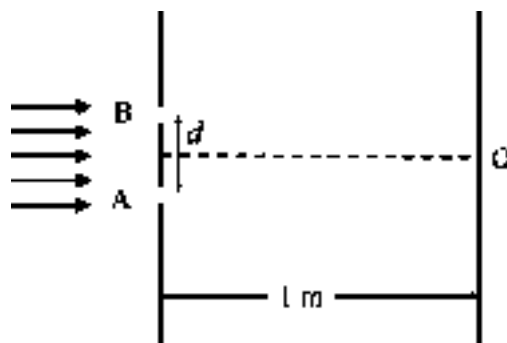

Q.15 The maximum speed in $\mu\text{m/s}$ at which the 8th bright fringe will move is _____.

PARAGRAPH II

Two particles, 1 and 2, each of mass m , are connected by a massless spring, and are on a horizontal frictionless plane, as shown in the figure. Initially, the two particles, with their center of mass at x_0 , are oscillating with amplitude a and angular frequency ω . Thus, their positions at time t are given by $x_1(t) = (x_0 + d) + a \sin \omega t$ and $x_2(t) = (x_0 - d) - a \sin \omega t$, respectively, where $d > 2a$. Particle 3 of mass m moves towards this system with speed $u_0 = a\omega/2$, and undergoes instantaneous elastic collision with particle 2, at time t_0 . Finally, particles 1 and 2 acquire a center of mass speed v_{cm} and oscillate with amplitude b and the same angular frequency ω .

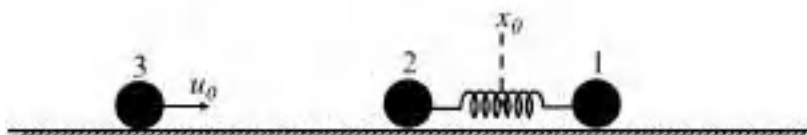

Q.16 If the collision occurs at time $t_0 = 0$, the value of $v_{\text{cm}}/(a\omega)$ will be _____.

PARAGRAPH II

Two particles, 1 and 2, each of mass m , are connected by a massless spring, and are on a horizontal frictionless plane, as shown in the figure. Initially, the two particles, with their center of mass at x_0 , are oscillating with amplitude a and angular frequency ω . Thus, their positions at time t are given by $x_1(t) = (x_0 + d) + a \sin \omega t$ and $x_2(t) = (x_0 - d) - a \sin \omega t$, respectively, where $d > 2a$. Particle 3 of mass m moves towards this system with speed $u_0 = a\omega/2$, and undergoes instantaneous elastic collision with particle 2, at time t_0 . Finally, particles 1 and 2 acquire a center of mass speed v_{cm} and oscillate with amplitude b and the same angular frequency ω .

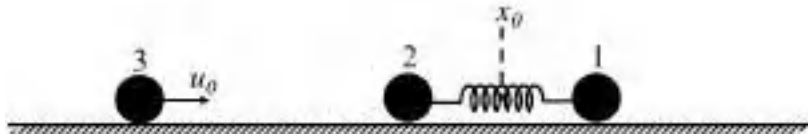

- Q.17 If the collision occurs at time $t_0 = \pi/(2\omega)$, then the value of $4b^2/a^2$ will be _____.

END OF THE QUESTION PAPER

SECTION 1 (Maximum Marks: 12)

- This section contains **FOUR (04)** questions.
- Each question has **FOUR** options (A), (B), (C) and (D). **ONLY ONE** of these four options is the correct answer.
- For each question, choose the option corresponding to the correct answer.
- Answer to each question will be evaluated according to the following marking scheme:
Full Marks : +3 If **ONLY** the correct option is chosen;
Zero Marks : 0 If none of the options is chosen (i.e. the question is unanswered);
Negative Marks : -1 In all other cases.

Q.1 According to Bohr's model, the highest kinetic energy is associated with the electron in the

- (A) first orbit of H atom
 (B) first orbit of He⁺
 (C) second orbit of He⁺
 (D) second orbit of Li²⁺

Q.2 In a metal deficient oxide sample, $M_xY_2O_4$ (M and Y are metals), M is present in both +2 and +3 oxidation states and Y is in +3 oxidation state. If the fraction of M^{2+} ions present in M is $\frac{1}{3}$, the value of X is _____.

- (A) 0.25 (B) 0.33 (C) 0.67 (D) 0.75

Q.3 In the following reaction sequence, the major product Q is

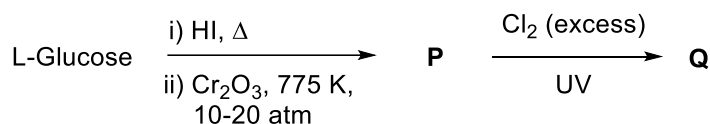

(A)

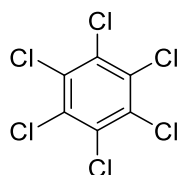

(B)

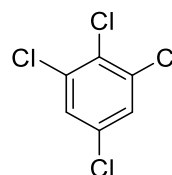

(C)

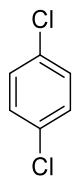

(D)

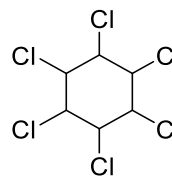

Q.4 The species formed on fluorination of phosphorus pentachloride in a polar organic solvent are

- (A) $[\text{PF}_4]^+[\text{PF}_6]^-$ and $[\text{PCl}_4]^+[\text{PF}_6]^-$ (B) $[\text{PCl}_4]^+[\text{PCl}_4\text{F}_2]^-$ and $[\text{PCl}_4]^+[\text{PF}_6]^-$
(C) PF_3 and PCl_3 (D) PF_5 and PCl_3

SECTION 2 (Maximum Marks: 12)

- This section contains **THREE (03)** questions.
- Each question has **FOUR** options (A), (B), (C) and (D). **ONE OR MORE THAN ONE** of these four option(s) is (are) correct answer(s).
- For each question, choose the option(s) corresponding to (all) the correct answer(s).
- Answer to each question will be evaluated according to the following marking scheme:
 - Full Marks* : +4 **ONLY** if (all) the correct option(s) is(are) chosen;
 - Partial Marks* : +3 If all the four options are correct but **ONLY** three options are chosen;
 - Partial Marks* : +2 If three or more options are correct but **ONLY** two options are chosen, both of which are correct;
 - Partial Marks* : +1 If two or more options are correct but **ONLY** one option is chosen and it is a correct option;
 - Zero Marks* : 0 If unanswered;
 - Negative Marks* : -2 In all other cases.
- For example, in a question, if (A), (B) and (D) are the **ONLY** three options corresponding to correct answers, then
 - choosing **ONLY** (A), (B) and (D) will get +4 marks;
 - choosing **ONLY** (A) and (B) will get +2 marks;
 - choosing **ONLY** (A) and (D) will get +2 marks;
 - choosing **ONLY** (B) and (D) will get +2 marks;
 - choosing **ONLY** (A) will get +1 mark;
 - choosing **ONLY** (B) will get +1 mark;
 - choosing **ONLY** (D) will get +1 mark;
 - choosing no option(s) (i.e. the question is unanswered) will get 0 marks and
 - choosing any other option(s) will get -2 marks.

Q.5 An aqueous solution of hydrazine (N_2H_4) is electrochemically oxidized by O_2 , thereby releasing chemical energy in the form of electrical energy. One of the products generated from the electrochemical reaction is $\text{N}_2(\text{g})$.

Choose the correct statement(s) about the above process

- (A) OH^- ions react with N_2H_4 at the anode to form $\text{N}_2(\text{g})$ and water, releasing 4 electrons to the anode.
- (B) At the cathode, N_2H_4 breaks to $\text{N}_2(\text{g})$ and nascent hydrogen released at the electrode reacts with oxygen to form water.
- (C) At the cathode, molecular oxygen gets converted to OH^- .
- (D) Oxides of nitrogen are major by-products of the electrochemical process.

Q.6 The option(s) with correct sequence of reagents for the conversion of **P** to **Q** is(are)

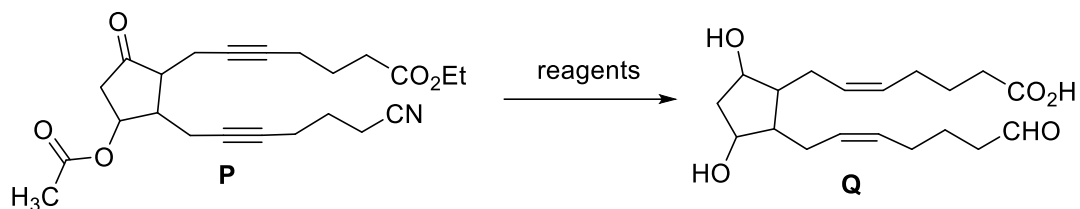

- (A) i) Lindlar's catalyst, H_2 ; ii) SnCl_2/HCl ; iii) NaBH_4 ; iv) H_3O^+
 (B) i) Lindlar's catalyst, H_2 ; ii) H_3O^+ ; iii) SnCl_2/HCl ; iv) NaBH_4
 (C) i) NaBH_4 ; ii) SnCl_2/HCl ; iii) H_3O^+ ; iv) Lindlar's catalyst, H_2
 (D) i) Lindlar's catalyst, H_2 ; ii) NaBH_4 ; iii) SnCl_2/HCl ; iv) H_3O^+

Q.7 The compound(s) having peroxide linkage is(are)

- (A) $\text{H}_2\text{S}_2\text{O}_7$
 (B) $\text{H}_2\text{S}_2\text{O}_8$
 (C) $\text{H}_2\text{S}_2\text{O}_5$
 (D) H_2SO_5

SECTION 3 (Maximum Marks: 24)

- This section contains **SIX (06)** questions.
- The answer to each question is a **NON-NEGATIVE INTEGER**.
- For each question, enter the correct integer corresponding to the answer using the mouse and the on-screen virtual numeric keypad in the place designated to enter the answer.
- Answer to each question will be evaluated according to the following marking scheme:
Full Marks : +4 If **ONLY** the correct integer is entered;
Zero Marks : 0 In all other cases.

Q.8 To form a complete monolayer of acetic acid on 1g of charcoal, 100 mL of 0.5 M acetic acid was used. Some of the acetic acid remained unadsorbed. To neutralize the unadsorbed acetic acid, 40 mL of 1 M NaOH solution was required. If each molecule of acetic acid occupies $P \times 10^{-23} \text{ m}^2$ surface area on charcoal, the value of **P** is _____.

[Use given data: Surface area of charcoal = $1.5 \times 10^2 \text{ m}^2\text{g}^{-1}$; Avogadro's number (N_A) = $6.0 \times 10^{23} \text{ mol}^{-1}$]

Q.9 Vessel-1 contains w_2 g of a non-volatile solute **X** dissolved in w_1 g of water. Vessel-2 contains w_2 g of another non-volatile solute **Y** dissolved in w_1 g of water. Both the vessels are at the same temperature and pressure. The molar mass of **X** is 80% of that of **Y**. The van't Hoff factor for **X** is 1.2 times of that of **Y** for their respective concentrations.

The elevation of boiling point for solution in Vessel-1 is _____ % of the solution in Vessel-2.

Q.10 For a double strand DNA, one strand is given below:

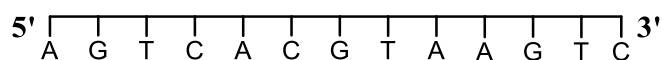

The amount of energy required to split the double strand DNA into two single strands is _____ kcal mol^{-1} .

[Given: Average energy per H-bond for A-T base pair = $1.0 \text{ kcal mol}^{-1}$, G-C base pair = $1.5 \text{ kcal mol}^{-1}$, and A-U base pair = $1.25 \text{ kcal mol}^{-1}$. Ignore electrostatic repulsion between the phosphate groups.]

Q.11 A sample initially contains only U-238 isotope of uranium. With time, some of the U-238 radioactively decays into Pb-206 while the rest of it remains undisintegrated.

When the age of the sample is $\mathbf{P} \times 10^8$ years, the ratio of mass of Pb-206 to that of U-238 in the sample is found to be 7. The value of \mathbf{P} is _____.

[Given: Half-life of U-238 is 4.5×10^9 years; $\log_e 2 = 0.693$]

Q.12 Among $[\text{Co}(\text{CN})_4]^{4-}$, $[\text{Co}(\text{CO})_3(\text{NO})]$, XeF_4 , $[\text{PCl}_4]^+$, $[\text{PdCl}_4]^{2-}$, $[\text{ICl}_4]^-$, $[\text{Cu}(\text{CN})_4]^{3-}$ and P_4 the total number of species with tetrahedral geometry is _____.

Q.13 An organic compound \mathbf{P} having molecular formula $\text{C}_6\text{H}_6\text{O}_3$ gives ferric chloride test and does not have intramolecular hydrogen bond. The compound \mathbf{P} reacts with 3 equivalents of NH_2OH to produce oxime \mathbf{Q} . Treatment of \mathbf{P} with excess methyl iodide in the presence of KOH produces compound \mathbf{R} as the major product. Reaction of \mathbf{R} with excess *iso*-butylmagnesium bromide followed by treatment with H_3O^+ gives compound \mathbf{S} as the major product.

The total number of methyl ($-\text{CH}_3$) group(s) in compound \mathbf{S} is _____.

SECTION 4 (Maximum Marks: 12)

- This section contains **TWO (02)** paragraphs.
- Based on each paragraph, there are **TWO (02)** questions.
- The answer to each question is a **NUMERICAL VALUE**.
- For each question, enter the correct numerical value of the answer using the mouse and the on-screen virtual numeric keypad in the place designated to enter the answer.
- If the numerical value has more than two decimal places, **truncate/round-off** the value to **TWO** decimal places.
- Answer to each question will be evaluated according to the following marking scheme:
Full Marks : +3 If **ONLY** the correct numerical value is entered in the designated place;
Zero Marks : 0 In all other cases.

“PARAGRAPH I”

An organic compound **P** with molecular formula $C_9H_{18}O_2$ decolorizes bromine water and also shows positive iodoform test. **P** on ozonolysis followed by treatment with H_2O_2 gives **Q** and **R**. While compound **Q** shows positive iodoform test, compound **R** does not give positive iodoform test. **Q** and **R** on oxidation with pyridinium chlorochromate (PCC) followed by heating give **S** and **T**, respectively. Both **S** and **T** show positive iodoform test.

Complete copolymerization of 500 moles of **Q** and 500 moles of **R** gives one mole of a single acyclic copolymer **U**.

[Given, atomic mass: H = 1, C = 12, O = 16]

Q.14 Sum of number of oxygen atoms in **S** and **T** is _____.

“PARAGRAPH I”

An organic compound **P** with molecular formula $C_9H_{18}O_2$ decolorizes bromine water and also shows positive iodoform test. **P** on ozonolysis followed by treatment with H_2O_2 gives **Q** and **R**. While compound **Q** shows positive iodoform test, compound **R** does not give positive iodoform test. **Q** and **R** on oxidation with pyridinium chlorochromate (PCC) followed by heating give **S** and **T**, respectively. Both **S** and **T** show positive iodoform test.

Complete copolymerization of 500 moles of **Q** and 500 moles of **R** gives one mole of a single acyclic copolymer **U**.

[Given, atomic mass: H = 1, C = 12, O = 16]

Q.15 The molecular weight of **U** is _____.

“PARAGRAPH II”

When potassium iodide is added to an aqueous solution of potassium ferricyanide, a reversible reaction is observed in which a complex **P** is formed. In a strong acidic medium, the equilibrium shifts completely towards **P**. Addition of zinc chloride to **P** in a slightly acidic medium results in a sparingly soluble complex **Q**.

Q.16 The number of moles of potassium iodide required to produce two moles of **P** is _____.

“PARAGRAPH II”

When potassium iodide is added to an aqueous solution of potassium ferricyanide, a reversible reaction is observed in which a complex **P** is formed. In a strong acidic medium, the equilibrium shifts completely towards **P**. Addition of zinc chloride to **P** in a slightly acidic medium results in a sparingly soluble complex **Q**.

Q.17 The number of zinc ions present in the molecular formula of **Q** is _____.

END OF THE QUESTION PAPER